

# Chamber, Enclosure & Test Cell Solutions for Test & Measurement Applications

Wireless

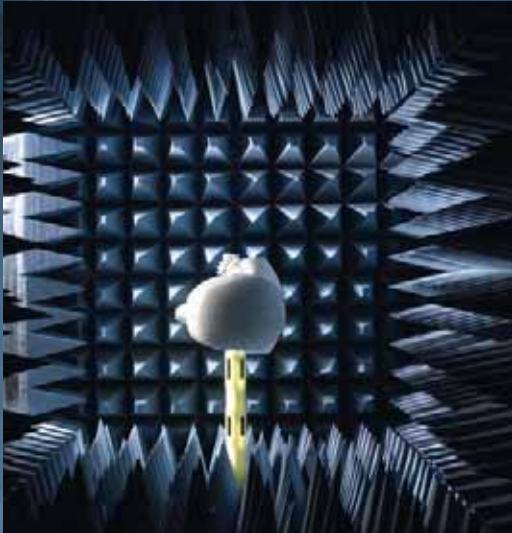

EMC



RF & Microwave



Acoustic

Enabling Your Success

 **ETS-LINDGREN**<sup>™</sup>  
An ESCO Technologies Company





<b>Applications and Standards . . . . .</b>	<b>3</b>
<b>Why Choose ETS-Lindgren . . . . .</b>	<b>5</b>
<b>Company Capabilities . . . . .</b>	<b>8</b>
<b>Systems and Solutions . . . . .</b>	<b>17</b>
<b>Chambers, Enclosures &amp; Test Cell Product Gallery . . . . .</b>	<b>29</b>
<b>Company History . . . . .</b>	<b>50</b>

# Applications and Standards

## Applications – RF and Microwave

- Design qualification and performance testing
- Antenna performance measurement
- Final measurement compliance testing
- Instrumentation repair and calibration
- Production line testing
- High voltage testing
- Medical equipment isolation
- Biomedical engineering labs
- Secure computer rooms

## Standards – RF and Microwave

- ANSI C63.4
- CISPR 16-1
- CID 09.12
- DIAM 50-3/DCID 1/21
- ENV 50140
- EN 61000-4-3
- FCC Part 15, 16 & 18
- IEC 61000-4-21
- IEEE 299
- MIL-STD-220A
- MIL-STD-285
- MIL-STD-461E
- MIL-STD-188-125
- NSA 65-5
- NSA 65-6/NSA 94-106
- NSA 73-2A
- SAE J1113/29
- UL 1283

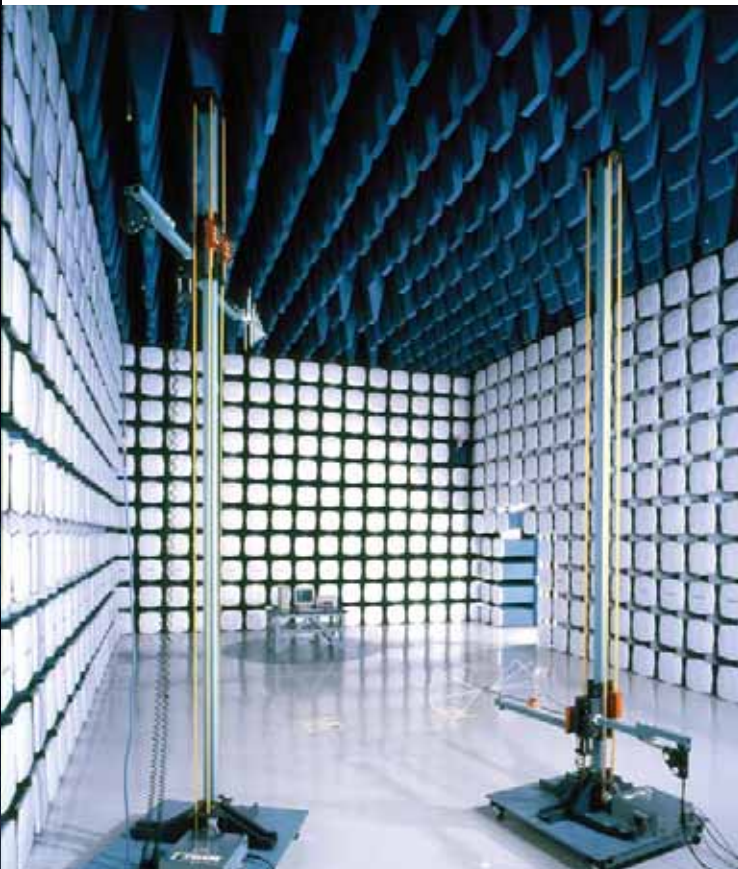

## Applications – Acoustic

- Product design and development
- Production line screening
- Audio research

## Standards – Acoustic

- ISO 140
- ISO 354
- ISO 717
- ISO 3741
- ISO 3742
- ISO 3743
- ISO 3744
- ISO 3745
- ISO 3746
- ISO 7779
- ANSI S12.6
- ANSI S12.10
- ANSI S12.11
- ANSI S12.31
- ANSI S12.32
- ANSI S12.34
- ANSI S12.35
- AMCA 300
- ASTM C423
- ASTM E90
- ASTM E596
- ASTM 1408





# Why Choose ETS-Lindgren?

## Experience and Expertise

ETS-Lindgren has the experience and expertise gained from over 70 years of designing, building and installing more than 10,000 electromagnetic, magnetic and acoustic shielding systems. We pioneered, developed and invented many of the technologies and practices used by the industry today. ETS-Lindgren holds more than 75 patents in shielding, absorber and related technologies.

*Our customers benefit by partnering with an experienced company that can deliver proven results.*

## Best Practices

ETS-Lindgren draws on the best technology and practices to create world-class shielding systems. At offices in Europe, Asia and the Americas, our engineers and technicians share knowledge from a broad range of disciplines: shielding, anechoic design, RF propagation, acoustics, structural mechanics, and more. The best ideas come together to create unique solutions beyond the grasp of most peer companies.

*Our customers benefit by partnering with a company that uses the best ideas from around the world to create practical solutions based on accepted engineering principles.*

## Best People

Many of our engineers and employees hold advanced degrees, and a few hold doctorates. You'll find many of them presenting technical papers and chairing sessions at industry symposiums throughout the year. A number of our engineers also serve on committees developing technical standards for the industry's future.

*Our customers benefit from partnering with a company that fields a team of knowledgeable experts who provide insight into the challenges ahead.*





## **Vertically Integrated**

As a vertically integrated manufacturer, ETS-Lindgren has control over all the processes that contribute to the final product. We design and manufacture our components for optimum performance — panels, doors, anechoic absorber, RF antennas, and positioning systems — and seamlessly integrate them into one system.

*Our customers benefit with peace of mind from partnering with a company that gives them a single source of responsibility.*

## **Internationally Recognized Credentials**

ETS-Lindgren's management system is compliant to ISO 9001:2000. We operate an in-house calibration lab accredited by the American Association of Laboratory Accreditation (A2LA), which has mutual recognition agreements with other international laboratory accreditation bodies; NVLAP, EA, ILAC, APLAC. ETS-Lindgren also operates an acoustic test lab accredited by the National Voluntary Laboratory Accreditation Program (NVLAP). In addition, we have the unique distinction of being named the first CTIA Authorized Test Lab (CATL) for mobile station over-the-air antenna performance testing.

A number of ETS-Lindgren employees are active members of IEEE, ANSI, SAE, ACES, AMTA, IEC, CTIA, ASA and INCE committees. The company is a corporate member of the Wi-Fi Alliance and WiMAX Forum.

*Our customers benefit by partnering with a company that has credentials with internationally recognized accrediting and standards bodies.*



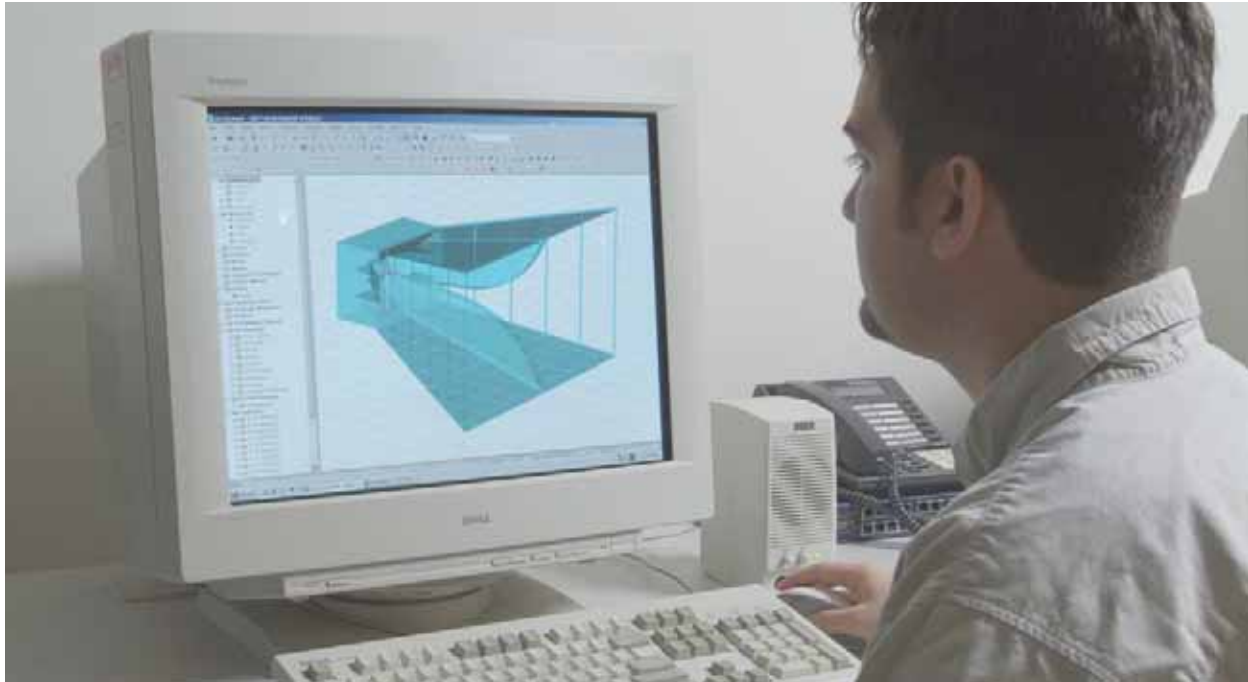

## Company Capabilities

### Engineering

A detailed and thorough engineering design is the foundation of a successful project. We begin by focusing on your key objectives and unique requirements and then apply our experience and engineering expertise. Having built thousands of chambers, we have ready-made solutions for the most commonly requested applications. But sometimes only a custom solution will satisfy your requirements. With our computerized systems, we can model all parameters and predict performance of each solution before construction begins.

As the largest commercial manufacturer of EMC, microwave and wireless test antennas, our staff also includes experienced RF design engineers. They understand the dynamics between a chamber's RF shield, absorber, and the DUT; the process of making measurements, and how all components interact. The result is a chamber with all components working together synergistically as a whole.

Our in-house engineering staff includes experienced experts across a broad number of key disciplines:

- Architectural
- Structural
- Mechanical
  - Electro-Mechanical
  - HVAC
- Electrical
- Fire detection & suppression
- RF Design
  - Anechoic treatment
  - RF shielding
  - RF propagation
- Acoustics

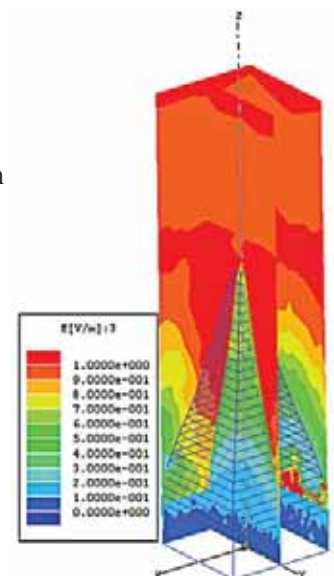



## Project Management

Managing the complex process of chamber construction is the responsibility of our Project Managers. They administer budgets and schedules and interface with the various project participants including the customer, general contractor, subcontractors and our own personnel. Project managers are assigned your project during the proposal stage. By maintaining project continuity from start to finish, the Project manager can ensure that resources, priorities and goals remain aligned throughout the entire process.

Our Project Managers perform a number of critical roles:

- Interface with
  - Customers
  - Company
    - Engineering
    - Purchasing
    - Contracts
    - Field installers
  - Subcontractors
- Administer budgets and schedules
- Report to senior management

ORBER LAYOUT

contained therein are the property of ETS LINDGREN  
agrees NOT to:

as other than those expressly authorized by  
information to any other person in  
however without the express written permission of  
this document either in whole  
permission of ETS LINDGREN

**ETS·LINDGREN™**  
An ESCO Technologies Company

Cedar Park Office :

1301 Arrow Point Drive Cedar Park, TX 78613  
352.531-6400 • 352.531-6500 • Fax

Chicago Office :

400 High Green Boulevard • Wheeling Heights, IL 60090  
630.907.9900 • 630.907.9901 • Fax

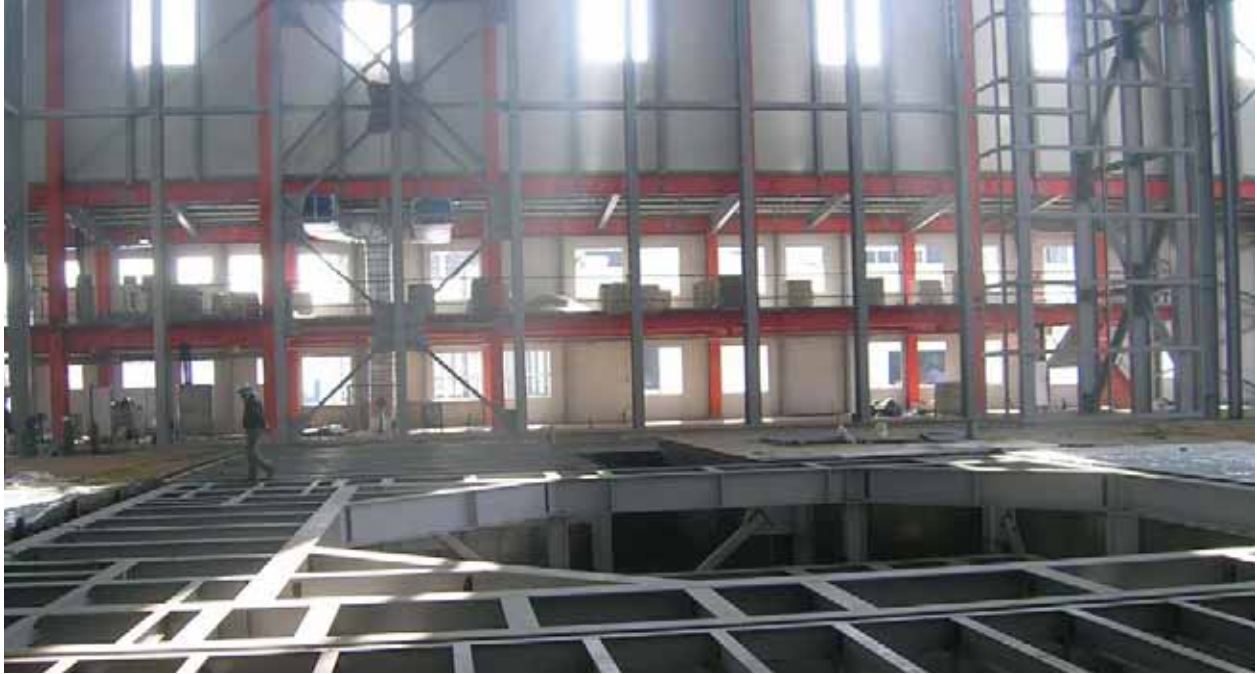

## **Manufacturing**

As a vertically integrated manufacturer, we have control over the key components and processes contributing to our final product. Our customers get seamless integration instead of patched together pieces. With modern manufacturing facilities in Europe, North America and Asia, we have a local presence for materials supply and support.

We manufacture many of the critical components included in our shielding systems such as:

- Shielding panels and assembly hardware
- RF and acoustic shield doors
- Anechoic absorber
- Waveguide vents
- Power line and signal filters
- Bulkhead penetrations
- RF shielded lighting systems
- RF hardened CCTV systems
- RF antennas
- EMF probes/sensors
- EUT positioning equipment
- Specialized measurement instrumentation





## Construction

ETS-Lindgren's experienced field construction crews supervise and perform all aspects of construction. With years of experience and training, our installers have the know-how to assure your shielding system is constructed and installed correctly. For example, we have the expertise to install doors, penetrations, and equipment correctly so chamber integrity is maintained and test results remain unaffected.

As a licensed construction company, we manage critical site work including:

- Site surveys and preparation
- Structural steel
- Shielding (modular and welded)
- RF/Acoustic sealing doors
- Absorber installation
- Electrical
- HVAC
- Fire protection
- Interior finishes
- EUT positioning equipment
- Specialized structures



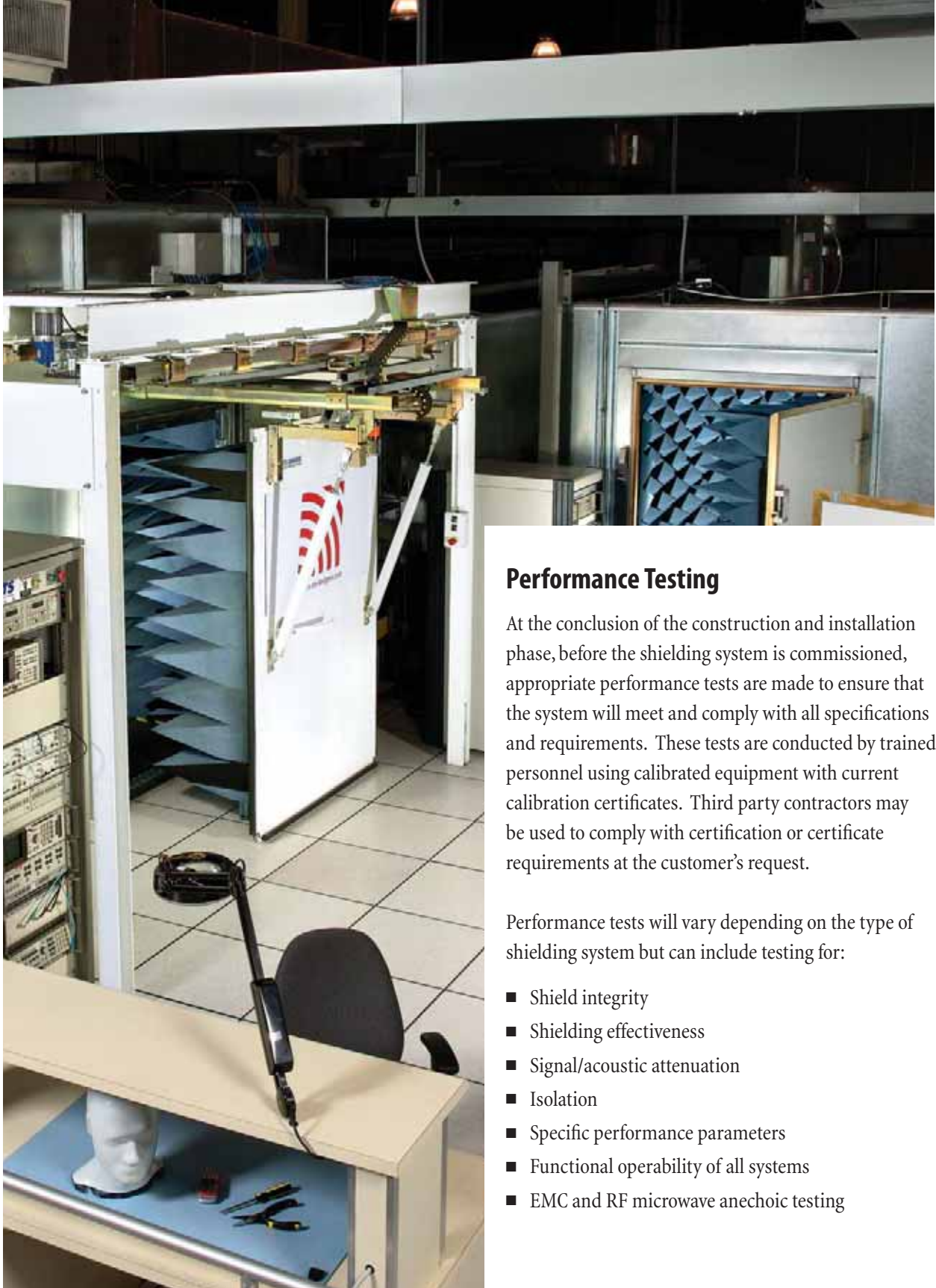

## Performance Testing

At the conclusion of the construction and installation phase, before the shielding system is commissioned, appropriate performance tests are made to ensure that the system will meet and comply with all specifications and requirements. These tests are conducted by trained personnel using calibrated equipment with current calibration certificates. Third party contractors may be used to comply with certification or certificate requirements at the customer's request.

Performance tests will vary depending on the type of shielding system but can include testing for:

- Shield integrity
- Shielding effectiveness
- Signal/acoustic attenuation
- Isolation
- Specific performance parameters
- Functional operability of all systems
- EMC and RF microwave anechoic testing



## Service & Support

With offices in Europe, North America and Asia, ETS-Lindgren has worldwide reach with a local presence. These locations and our independent network of representatives and distributors in more than 30 countries allow us to:

- Ensure the value of our warranties
- Provide local support
  - consultation
  - training
  - upgrades
  - maintenance
  - repair
  - refurbishment
  - relocation

From our headquarters in Cedar Park, Texas, our A2LA and NVLAP accredited labs and CTIA authorized test lab (CATL) allow us to perform these tests and services.

### *For RF, Microwave, EMC, and Wireless:*

- Calibrate antennas, EMF probes and sensors per applicable standards
- Repair antennas, EMF probes and sensors
- Perform active and passive spherical antenna/ radiation pattern measurements
- Measure the radiated performance of wireless devices to various over the air (OTA) test requirements including CTIA, 3GPP, Wi-Fi and WiMAX
- Conduct hearing aid compatibility (HAC) testing of wireless handsets

We also have the ability to perform field tests and measurements such as:

- Calibration (NSA) of EMC chambers
  - SAC, FAC/FAR
- Calibration of OATS



- Pre-construction site surveys for RF and MRI conditions
- Shield systems performance testing

### *For Acoustics:*

- Conduct acoustic measurements in compliance with standards
  - ISO 3743, ISO 3741, ISO 3742 ISO 3744 ISO 3745, ISO 3746
  - ANSI S12.6, ANSI S12.10, ANSI S12.11
  - ANSI S12.31, ANSI S12.32, ANSI S12.34, ANSI S12.35
  - AMCA 300
  - ASTM C423, ASTM E90, ASTM E596, ASTM 1408

We also have the ability to perform field tests and measurements such as:

- Calibration of acoustic chambers
  - Anechoic and hemi – anechoic chambers
  - Precision and Survey Grade
- Pre-construction site surveys
- On-site noise and vibration studies
- Shield systems performance testing

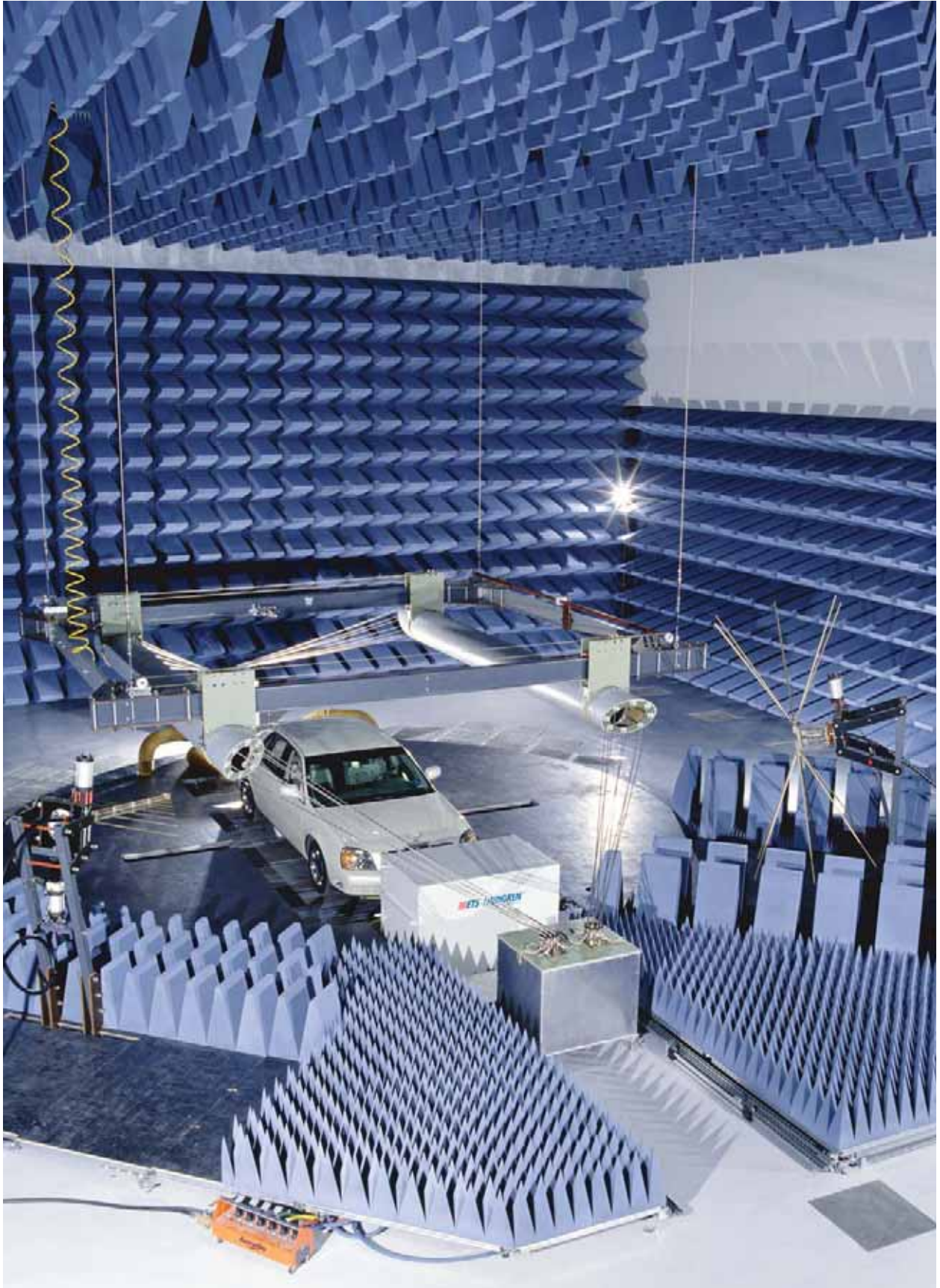



## Customized Solutions

There's no need to accept a "one size fits all" solution when your requirements don't fit a predefined template. ETS-Lindgren has experienced in-house experts and a vertically integrated manufacturing capability that allows you to achieve almost any requirement. For example:

- A wireless service provider needed to be able to test the operability of wireless phones taken in to local customer service centers. We developed a bench-top test cell with an integral antenna that enabled the provider to diagnose the phones quickly and accurately.
- A large automotive manufacturer needed a chamber that could test fully operational vehicles at speeds up to 112 km, and the special antennas used to perform the test. Our chamber experts designed a facility with an integral dynamometer, air cooling and exhaust systems for the vehicles while our RF experts designed the one-of-a-kind antennas and positioning system.
- A well known integrated circuit manufacturer needed to test its products for both EMC emissions and acoustic properties. We built one chamber that could do both without compromising either EMC or acoustic measurement results.

More commonly, our customers need to build a shielding system in the confines of an existing laboratory or building. The available space does not provide the volume needed for optimal chamber performance. With our computerized modeling capability, we can design a chamber that maximizes available space to deliver the required performance.

At ETS-Lindgren, we use our engineering and manufacturing resources to create custom solutions for unique requirements.

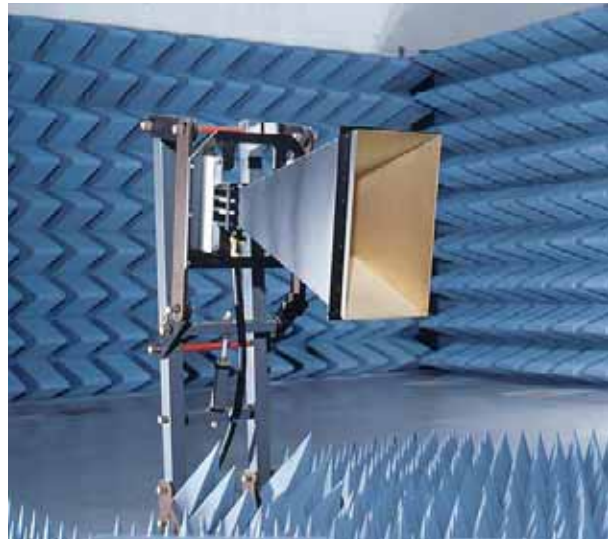
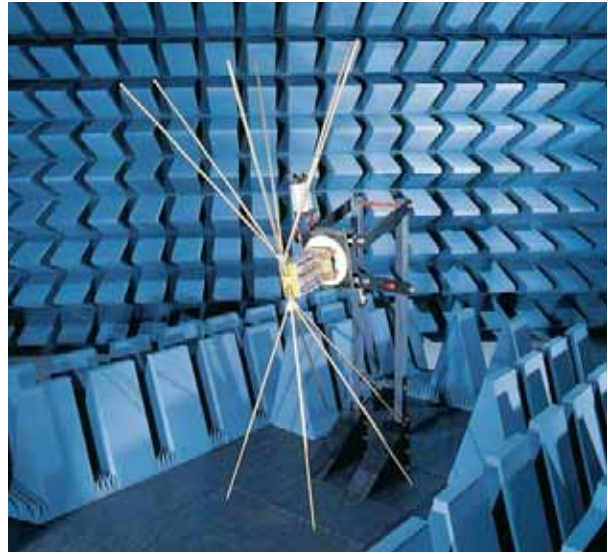





# Systems and Solutions

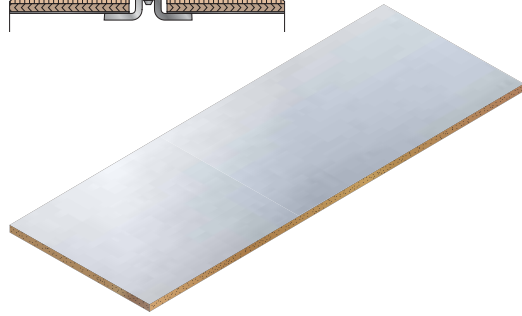
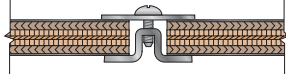

Series 81



Series 101

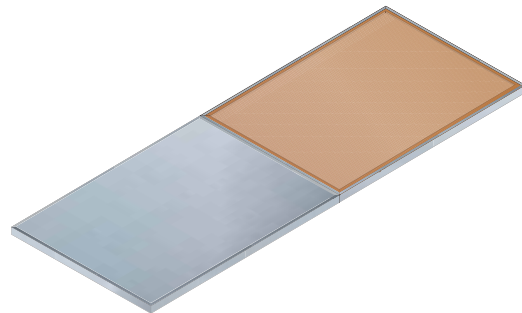

Series 71

## RF Shielding Systems

ETS-Lindgren offers five types of RF shielding systems. Each is designed for specific applications and attenuation levels. All of the systems except welded steel are modular and can be used to create almost any configuration. At the end of a project, they can be demounted and transported to a new location.

### Modular Panel Systems:

- **Series 81** – Consists of a Double Laminated Steel (DLS) panel made with solid sheets of galvanized steel laminated to a dimensionally stable high density core. Fasteners are used to clamp the panels together to form enclosures. Assembles with “hat and flat” clamping system.
- **Series 101** – Consists of a “Pan”-type panel made from single sheets of steel. These are bolted together along the panel’s flanged edges to form enclosures. Pan shielding was developed by Euroshield in the 1970’s.
- **Series 71** – Consists of a double layer of copper screen mesh upper panel section, and a DLS lower panel section. Assembles with “hat and flat” clamping system.
- **DEI** – Consists of a Double Electricly Isolated (DEI) doubled layer of bronze or copper screen mesh panel, with the lower section covered by a protective wood grain paneling. Assembles with “hat and flat” clamping system.

### Welded Steel:

- Welded steel is considered to be the highest performing shielding system. It is ideal for government complexes and research facilities.





## Acoustic Panel Systems

ETS-Lindgren's acoustic panel system consists of seven types of panels, each pre-engineered and tested for a specific level of performance. The benefit is that different panel types can be used together in one chamber to provide a unique solution with a predictable level of performance.

### Modular Panel Types:

- **Type 1** – For use in areas with an ambient mid-frequency noise range of 250 – 2000 Hz. Consists of a 10.2 cm (4 in) thick panel with 16 gauge outer surface, a 22 gauge perforated inner surface, filled with acoustical material.
- **Type 2** – Our most popular panel. For use in areas requiring higher level noise reduction. The same construction as a Type 1 panel with the addition of a gypsum board barrier.
- **Type 4** – For use when absorption performance is needed for a common wall within an enclosure or barrier wall. Consists of a 10.2 cm (4 in) thick panel with 22 gauge perforated surfaces, and a steel inner septum filled with acoustical material.

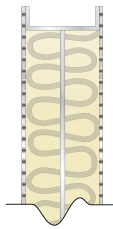
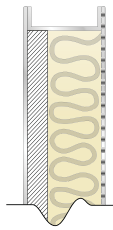

- **Type 5** – For use in areas with extremely high noise levels with severe low frequency noise, when interior absorption is not required and interior surfaces may be exposed to water or other fluids. Consists of a 10.2 cm (4 in) thick panel with 16 gauge surfaces, filled with acoustical material.



- **Type 6** – For use in areas requiring maximum noise reduction where interior absorption is not required and interior surfaces may be exposed to water and other fluids. Similar to a Type 2 panel except that a 16 gauge solid surface replaces the 22 gauge perforated inner surface.

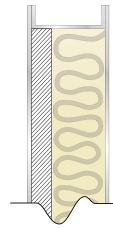

- **Type 8** – For use in areas with extremely high noise levels or when low frequency noise is a problem. Similar to Type 1 and 2 panels with the addition of a gypsum board barrier and a steel septum.

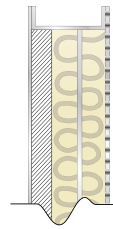

- **Type 12** – For use when a combination of high absorption and transmission loss is required. Panel is 15.2 cm (6 in) thick with a 16 gauge outer surface and a 22 gauge inner surface, with a gypsum board barrier and acoustical filler.

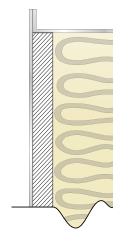





## RF Shielded Door Systems

Our Euroshield brand of doors is unique in the industry. Both the swing and sliding door styles in this series open and close parallel to the door frame. The benefits are reduced stress and premature wear of the RF contacts, so down time for maintenance is reduced and repair costs are less.

### Options (may not be available on all models)

- Pneumatic operation
- Code lock, card lock entry
- Microswitch for door open/closed indicator
- Slope entry ramp
- Custom sizes

### Swing Doors

#### 201 Swing Door

- Measured shielding effectiveness per MIL-STD 285
  - E-field: 110 dB @ 200 kHz - 10 GHz
  - H-field: 200 dB @ 1 kHz; 56 dB @ 10 kHz  
100 dB @ 200 kHz
- Standard door opening sizes: 914 mm x 2134 mm and 1219 mm x 2134 mm

#### Euroshield RFD-60 Swing Door

- Measured shielding effectiveness per MIL-STD 285
  - E-field: 120 dB @ 1 kHz - 10 GHz
  - H-field: 60 dB @ 10 kHz; 120 dB @ 10 MHz
- Standard door opening sizes: 800, 1000 or 1200 mm x 2000 mm

#### Euroshield RFDD-60 Double Swing Door

- Measured shielding effectiveness per MIL-STD 285
  - E-field: 120 dB @ 1 kHz - 10 GHz
  - H-field: 60 dB @ 10 kHz; 120 dB @ 10 MHz
- Standard door opening sizes: 800, 1000 or 1200 mm x 2000 mm



#### Euroshield RFD-100 and RFD-F/A-100 Swing Doors

- Measured shielding effectiveness per MIL-STD 285
  - E-field: 120 dB @ 1 kHz - 20 GHz
  - H-field: 80 dB @ 10 kHz; > 100 dB @ 100 kHz; 120 dB @ 1 MHz
- Standard door opening sizes: 800, 1000 or 1200 mm x 2000 mm







## Sliding Doors

### Euroshield RFSD-100, RFSD-F-100 and RFSD-F/A-100 Sliding Doors

- Measured shielding effectiveness per MIL-STD 285
  - E-field: 120 dB @ 1 kHz - 20 GHz
  - H-field: 80 dB @ 10 kHz; > 100 dB @ 100 kHz; 120 dB @ 1 MHz
- Standard door opening sizes: 800, 1000 or 1200 mm x 2000 mm
- Sizes available up to 3 m x 3 m

### Euroshield SRFSD-100, SRFSD-F/A-100ABS Sliding Door

- Measured shielding effectiveness per MIL-STD 285
  - E-field: 120 dB @ 1 kHz - 20 GHz
  - H-field: 80 dB @ 10 kHz; > 100 dB @ 100 kHz; 120 dB @ 1 MHz
- Standard door opening sizes: 3 m x 3 m, 3.6 m x 3.6 m, 4.8 m x 4.8 m, 6 m x 6 m
- Requires 200 – 240 VAC/50 – 60 Hz, single phase





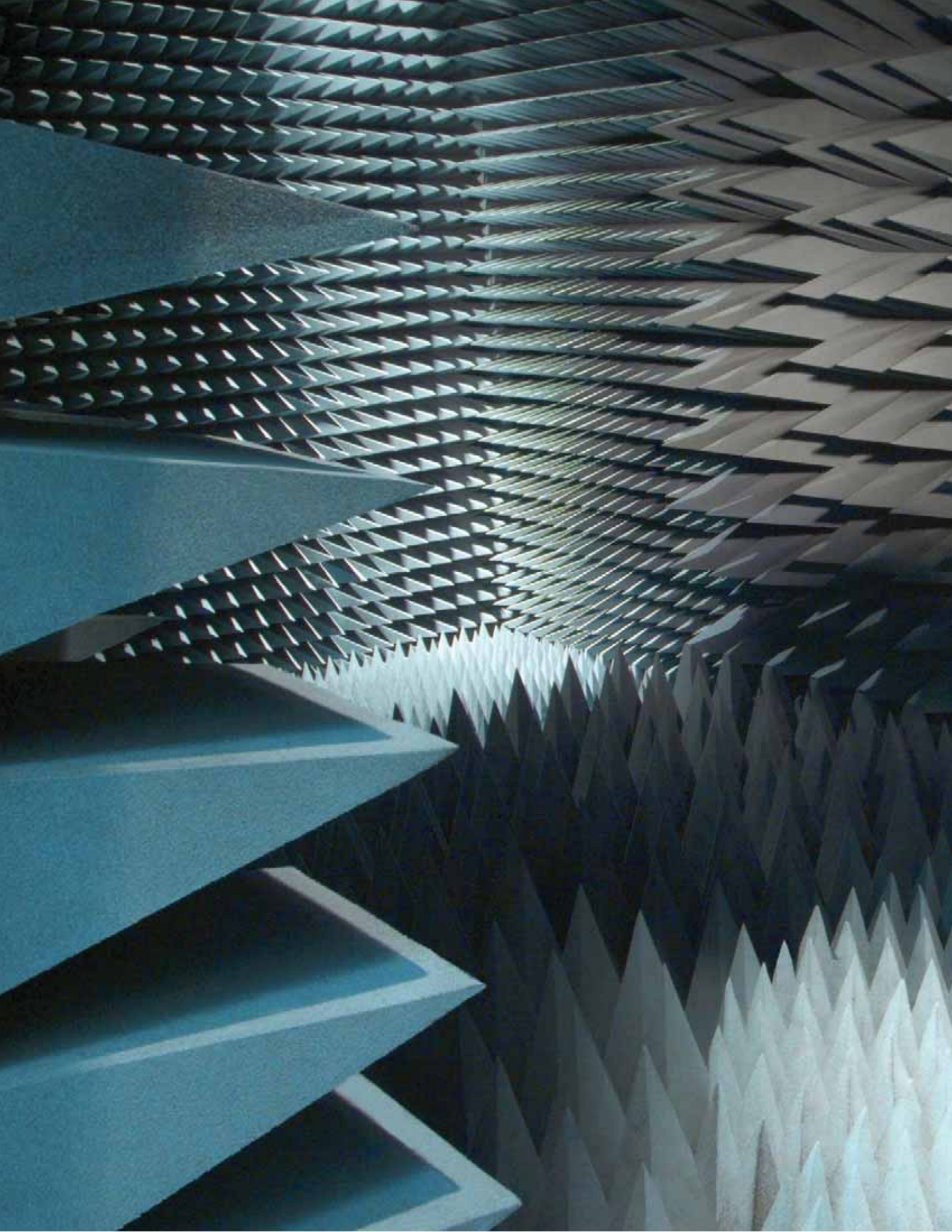



## Anechoic Absorber

ETS-Lindgren's anechoic absorber manufacturing plant is the largest in the world and can produce more than 10.5 million board feet per year. More importantly, we have the ability to create customized absorber with special formulations and physical geometries to meet unique requirements. Workstations running advanced numerical modeling software are used to develop the right solution, which is then prototyped and tested to confirm predicted results.

All ETS-Lindgren absorber products are manufactured in accordance with established quality control and assurance standards. Each piece of absorber is serialized, providing traceability throughout the manufacturing process.

### RF Absorber Types:

- EMC Absorber
  - FerroSorb™ FS ferrite tile-backed open cell absorber
  - FerroSorb™ PS™ ferrite tile-backed closed cell absorber
  - FT ferrite tile
  
- Microwave Absorber
  - EHP high performance absorber
  - EHP-CV convolute absorber
  - EHP-WW walkway absorber
  - EMC broadband absorber
  - CRV curvilinear absorber
  - HP high power absorber
  - FL flat laminate absorber
  - FF filter foam absorber
  - Wedge absorber
  - Lossy foam absorber
  - Miter cut absorber

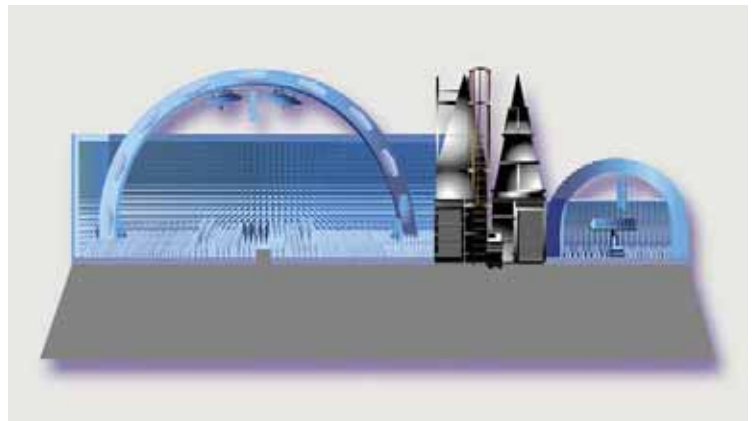











## Accessories and Equipment

ETS-Lindgren manufactures most of the equipment or accessories required for RF testing including:

- Antennas
  - EMC
  - Microwave
  - Wireless test
  
- EMF sensors
  - Broadband E-field
    - Laser powered
    - Battery powered
  - Shaped Response
    - FCC requirements
    - ICNIRP requirements
  
- Positioning equipment
  - Antenna towers
  - Equipment (DUT) turntables
  - Multi-axis DUT positioners
  
- RF hardened CCTV cameras
- Power line & RF signal line filters
- RF shielded lighting
- RF honeycomb vents
- RF bulkhead feedthroughs
- Specialized equipment





## Chambers, Enclosures & Test Cell Product Gallery

### EMC Chambers

#### FACT™

Free-space Anechoic Chamber Test (FACT) chambers represent state-of-the-art technology for EMC measurement using de-mountable modular panels, high performance anechoic absorber, and sliding, swing or hinged doors. FACT chambers provide the test environment you need for meeting most international emissions and susceptibility standards such as CISPR, IEC, VCCI, ANSI, FCC, SAE, and more.





## FACT™ 10

- 26 MHz – 18 GHz frequency range (40 GHz optional)
- 4 m antenna scan height
- 2.0 m, to 6.0 m Quiet Zone size solutions  
(other Quiet Zone sizes available)
- 0 to 6 dB field uniformity
- NSA performance options:
  - STANDARD  $\pm 4.0$  dB
  - STANDARD PLUS  $\pm 3.5$  dB
  - PREMIUM  $\pm 3.0$  dB
- Typical size for FACT 10-4.0 STANDARD PLUS chamber: 20.40 x 12.81 x 9.91 m with structural steel



### FACT™ 5

- 26 MHz – 18 GHz frequency range (40 GHz optional)
- 4 m antenna scan height
- 2.0 to 3.0 m Quiet Zone size solutions (other Quiet Zone sizes available)
- 0 to 6 dB Field Uniformity
- NSA Performance Options:
  - STANDARD  $\pm 4.0$  dB
  - STANDARD PLUS  $\pm 3.5$  dB
  - PREMIUM  $\pm 3.0$  dB
- Typical size for FACT 5-4.0 STANDARD PLUS chamber: 12.06 x 7.95 x 6.78 m with structural steel



### FACT™ 3

- 26 MHz – 18 GHz frequency range (40 GHz optional)
- 4 m antenna scan height
- 1.2 m to 2.0 m Quiet Zone size solutions (other Quiet Zone sizes available)
- 0 to 6 dB Field Uniformity
- NSA Performance Options:
  - STANDARD  $\pm 4.0$  dB
  - STANDARD PLUS  $\pm 3.5$  dB
  - PREMIUM  $\pm 3.0$  dB
- Typical size for FACT 3-2.0 STANDARD PLUS chamber: 9.02 x 7.34 x 6.12 m with structural steel



## SpaceSaver™

SpaceSaver™ chambers have many of the construction features found in our FACT™ chambers including demountable modular panels, high performance anechoic absorber (or ferrite tile), and sliding, swing or hinged doors. Small and compact, SpaceSaver chambers provide a test environment for emission pre-scan measurements, susceptibility compliance standards such as IEC, and design and debugging applications.



## SpaceSaver™ 26

- 26 MHz – 1 GHz frequency range
- 2 m antenna scan height
- 1.5 m Quiet Zone size
- 0 to 6 dB Field Uniformity
- NSA Performance:
  - 30 MHz – 300 MHz  $\pm$  6.0 dB
  - 300 MHz – 1 GHz  $\pm$  4.0 dB
- Typical size for SpaceSaver 26 chamber:  
6.88 x 3.20 x 3.22 m with structural steel

## SpaceSaver™ 26 H

- 26 MHz – 18 GHz frequency range (40 GHz optional)
- 2 m antenna scan height
- 1.5 m Quiet Zone size
- 0 to 6 dB Field Uniformity
- NSA Performance:
  - 30 MHz – 300 MHz  $\pm$  6.0 dB
  - 300 MHz – 18 GHz  $\pm$  4.0 dB
- Typical size for SpaceSaver 26 chamber:  
7.47 x 3.20 x 3.22 m with structural steel

## SpaceSaver™zzz PC

- 30 MHz – 18 GHz frequency range (40 GHz optional)
- Fixed antenna height
- 1.2 m Quiet Zone size
- 0 to 6 dB Field Uniformity
- NSA Performance:
  - 30 MHz – 300 MHz  $\pm$  8.0 dB
  - 300 MHz – 18 GHz  $\pm$  4.0 dB
  - (Performance is guaranteed with correction factor below 1 GHz)
- Typical size for SpaceSaver PC chamber:  
6.25 x 3.25 x 2.60 m with structural steel

## FACT™ 25

Our FACT 25 chambers share the construction features of our FACT chambers including demountable modular panels, high performance anechoic absorber and RF sealing doors. FACT 25 chambers provide a test environment specifically for the CISPR 25 standard for measurement of automotive components.

- 70 MHz – 18 GHz frequency range (40 GHz optional)
- - 6 dB Reflectivity Loss per CISPR 25
- Typical size for CISPR 25 chamber:  
7.25m x 6.94 x 4.75 m (exterior)



## MIL-STD 461E

Our MIL-STD 461E chambers share the construction features of our FACT chambers including de-mountable modular panels, high performance anechoic absorber and RF sealing doors. MIL-STD 461E chambers provide a test environment specifically for MIL-STD 461 E measurements.

- 80 MHz – 40 GHz frequency range
- Reflectivity Loss better than:
  - - 6 dB, 80 MHz – 250 MHz
  - - 10 dB, above 250 MHz
- Performs Radiated and Conducted Emissions & Susceptibility tests (RE, RS, CE, CS)
- Typical size for MIL-STD 461E chamber:  
6.31 x 6.31 x 3.91 m (exterior)





## SMART™

Statistical Mode Averaging Reverberation Test (SMART) chambers provide an electromagnetic environment for performing both radiated susceptibility and emissions testing. Benefits include lower construction cost, high field to input power ratios, homogeneous fields, and large test object size to chamber volume ratios. IEC 61000-4-21 draft standard addresses the reverberation chamber as a test environment.

## SMART™ 80

- 80 MHz – 18 GHz frequency range
- Continuous or Stepped Tuner rotation
- Typical size for SMART 80 chamber:  
13.44 x 6.09 x 4.87 m (interior)



## SMART™ 200

- 200 MHz – 18 GHz frequency range
- Continuous or Stepped Tuner rotation
- Typical size for SMART 80 Chamber:  
4.83 x 3.60 x 3.04 m (interior)



Courtesy of Philips Electronics

## Series 71 and DEI Modular Screen Rooms

Our Series 71 and DEI (Double Electrically Isolated) modular screen rooms provide the convenience of “hear-through, see-through” construction while still providing excellent RF attenuation levels. The upper half and ceiling of the rooms are wire mesh screen. Series 71 uses two layers of 22 x 22 strands per 2.54 cm (1.0 in) of copper mesh screen. DEI uses two layers of 22 x 22 strands per 2.54 cm (1.0 in) bronze mesh screen. The lower half of both types of room is constructed with Series 81 panels.

DEI construction is unique in that consists of two completely contiguous shields electrically separated from each other except at a single point, where they are grounded. The DEI concept provides a high level of EMI/RFI shielding compared to other designs.



## Typical Applications for Screen Rooms

- Product repair
- Product calibration
- Production testing
- EMI/RFI testing and research
- Security

## Series 71 Screen Rooms

- Performance
  - H-field
    - 18 dB @ 1 kHz
    - 50 dB @ 14 kHz
  - E-field
    - 100 dB @ 14 kHz – 10 MHz
  - Plane Wave
    - 100 dB @ 400 MHz
    - 90 dB @ 1 GHz
    - 80 dB @ 2 GHz
  - Microwave
    - 60 dB @ 10 GHz

## DEI Screen Rooms

- Performance
  - H-field
    - 40 dB @ 14 kHz
  - E-field
    - 120 dB @ 14 kHz
  - Plane Wave
    - 100 – 120 dB @ 450 MHz
    - 85 – 100 dB @ 1 GHz
  - Microwave
    - 40 – 70 dB @ 10 GHz



## Wireless Chambers

Our full-sized and compact wireless test chambers are designed for making active and passive spherical antenna/radiation pattern measurements. Rectangular and tapered chambers are differentiated by the size of their quiet zone and frequency range. Tapered AMS-8600 and Rectangular AMS-8500 chambers can qualify for final certification testing.

*Eligible for CTIA CATL certification for OTA measurement:*

### AMS 8600 Tapered Chambers

- 400 MHz – 6 GHz frequency range
- .06 m Quiet Zone size
- Multi-Axis Positioning System
- EMQuest EMQ-100 Antenna Measurement Software
- Typical size for AMS-8600 tapered chambers:  
13.72 x 3.25 x 3.25 m with structural steel

### AMS 8500 Rectangular Chamber

- 700 MHz – 6 GHz frequency range
- .09 m Quiet Zone size
- Multi-Axis Positioning System
- EMQuest EMQ-100 Antenna Measurement Software
- Typical size for AMS-8500 tapered chamber:  
7.32 x 3.66 x 3.66 m with structural steel



*Suitable for pre-certification measurement*

### AMS 8100, 8200 Rectangular Chambers

- 800 MHz – 6 GHz frequency range, AMS-8100
- 700 MHz – 6 GHz frequency range, AMS-8200
- .06 m Quiet Zone size
- Single-Axis Positioning System, AMS-8100
- Multi-Axis Positioning System, AMS-8200
- EMQuest EMQ-100 Antenna Measurement Software
- Typical size for AMS-8100 rectangular chamber:  
4.55 x 2.85 x 2.85 m with structural steel
- Typical size for AMS-8200 rectangular chamber  
7.55 x 3.90 x 4.05 m with structural steel

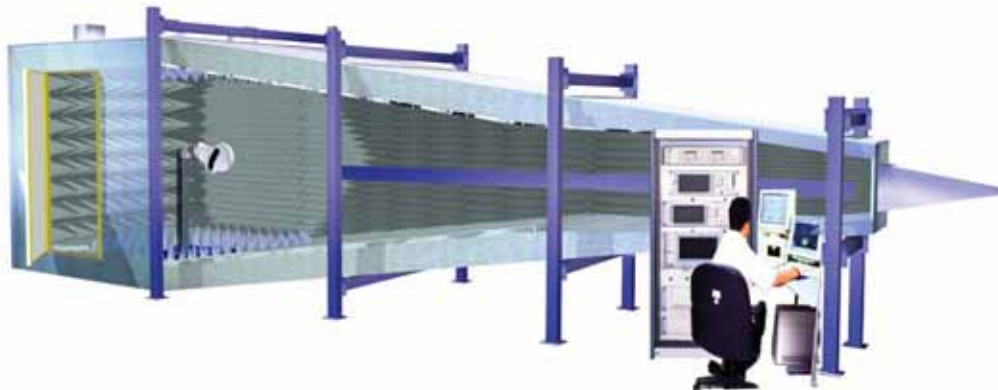

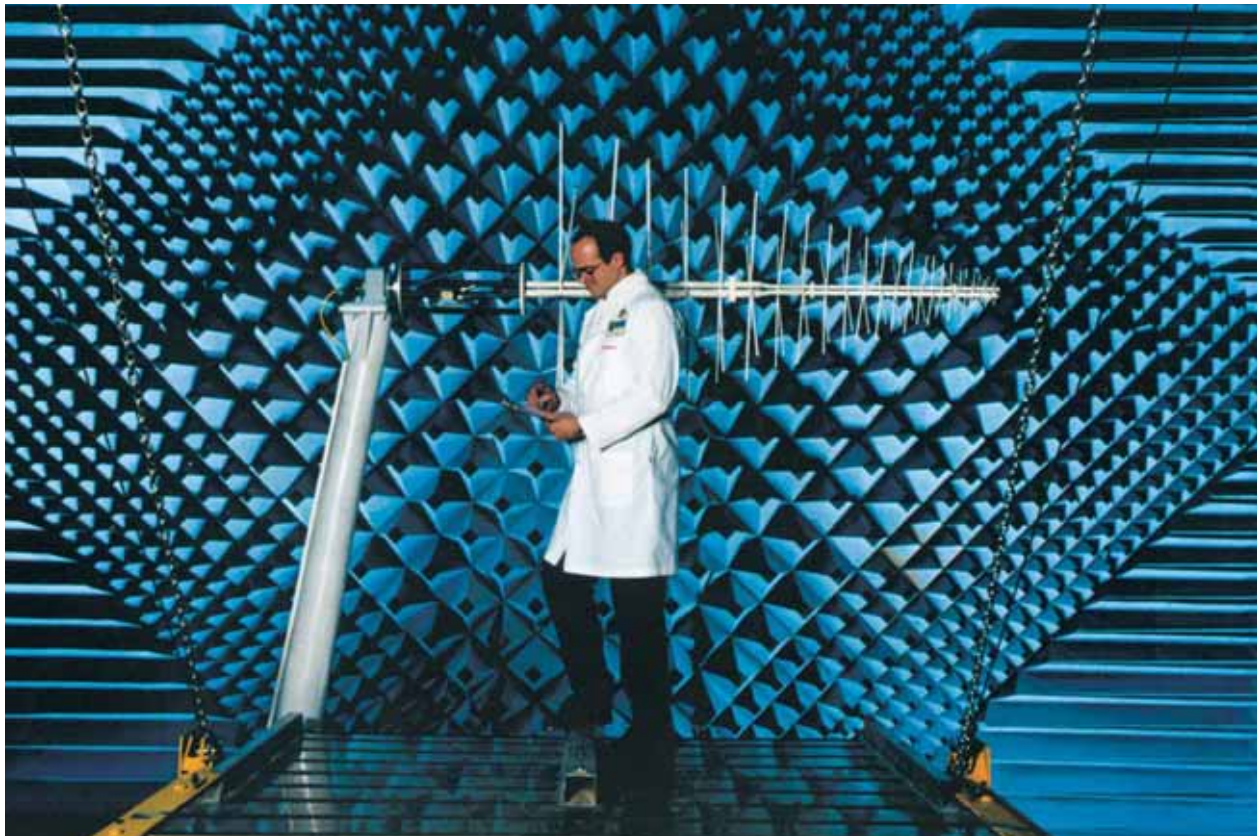



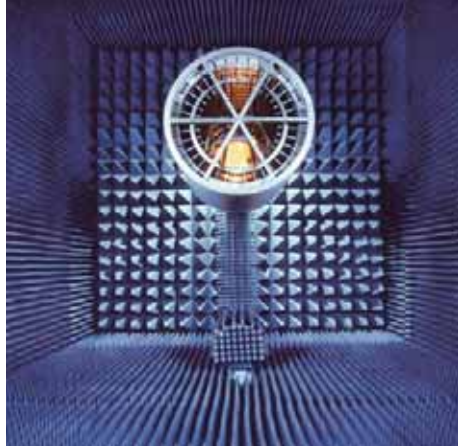

## Microwave Chambers

ETS-Lindgren manufactures Microwave Chambers for a number of applications including; Radar Cross Section, Near Field, Satellite and Compact Range measurement. Typically, these chambers have all their surfaces lined with anechoic absorber to create a free space environment. Microwave chambers can be almost any size as long as the anechoic absorbers are able to provide the required reflection loss at the required frequency.

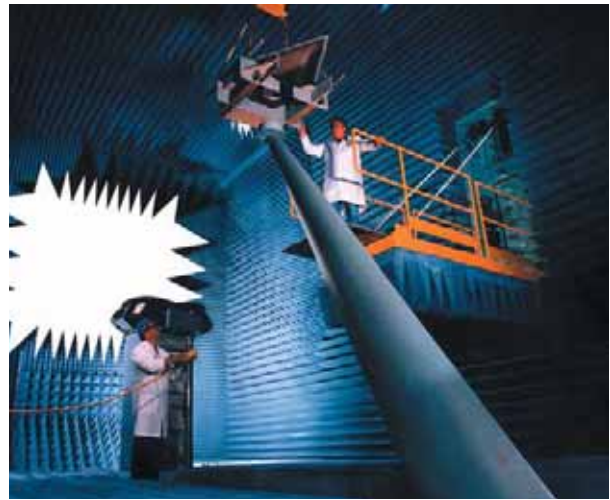



## Acoustic Chambers

### “A” Series Anechoic Chambers for Test & Measurement

A Series Anechoic Chambers are designed for making Precision or Engineering Grade measurements for audio and acoustic research.

#### A80-3.0

- 80 Hz frequency of interest
- Typical exterior size 9.58 x 9.55 x 7.92 m

#### A80-2.0

- 80 Hz frequency of interest
- Typical exterior size 8.33 x 8.33 x 8.54 m

#### A100-2.0

- 100 Hz frequency of interest
- Typical exterior size 7.32 x 7.32 x 7.62 m

#### A100-1.5

- 100 Hz frequency of interest
- Typical exterior size 6.71 x 6.71 x 6.78 m

#### A100-1.0

- 100 Hz frequency of interest
- Typical exterior size 5.49 x 5.49 x 5.56 m

#### A250-1.0

- 250 Hz frequency of interest
- Typical exterior size 3.65 x 3.65 x 3.73 m

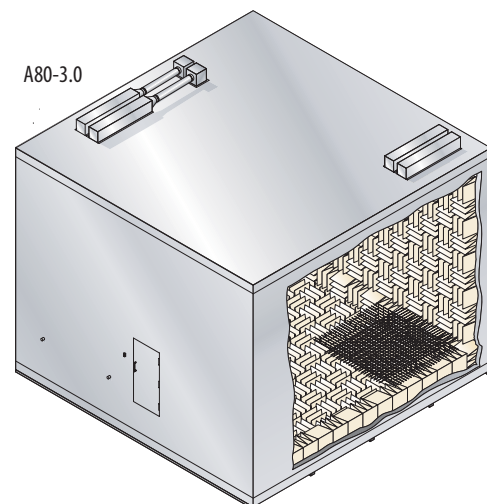



## R Series

R Series Reverberation Chambers are designed for making Precision and Engineering Grade measurements of HVAC systems, building materials, and products where absorption measurements are important.

### R63-1

- >63 Hz frequency of interest
- 300 cubic meters
- HVAC, building, and product testing
- Typical exterior size 8.64 x 7.34 x 5.24 m

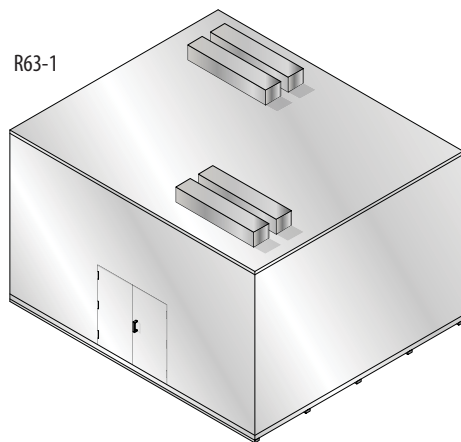

### R80-1

- >80 Hz frequency of interest
- 250 cubic meters
- HVAC, building, and product testing
- Typical exterior size 8.22 x 6.50 x 5.31 m

### R100-1

- >100 Hz frequency of interest
- 200 cubic meters
- Building and product testing
- Typical exterior size 7.59 x 6.05 x 4.90 m

### R125-1

- >125 Hz frequency of interest
- 150 cubic meters
- Building and product testing
- Typical exterior size 6.88 x 5.55 x 4.50 m

### R160-1

- >160 Hz frequency of interest
- 100 cubic meters
- Building and product testing
- Typical exterior size 6.05 x 4.88 x 3.99 m

### R200-1

- >200 Hz frequency of interest
- 70 cubic meters
- HVAC, product testing
- Typical exterior size 5.41 x 4.60 x 3.66 m



## HA Series

HA Series Hemi Anechoic Chambers are designed for making Precision and Engineering Grade measurements of automobiles, and large and small-sized equipment.

### HA80SV

- >80 Hz frequency of interest
- Automobiles and large equipment
- Precision and Engineering Grade measurements
- Typical exterior size 11.28 x 8.2 x 7.0 m

### HA100SV

- >100 Hz frequency of interest
- Small automobiles and equipment
- Precision and Engineering Grade measurements
- Typical exterior size 9.75 x 7.30 x 4.85 m

### HA100-2.0

- >100 Hz frequency of interest
- Medium to small-sized products
- Precision and Engineering Grade measurements
- Typical exterior size 7.32 x 7.32 x 5.45 m

### HA100-1.5

- >100 Hz frequency of interest
- Medium to small-sized products
- Precision and Engineering Grade measurements
- Typical exterior size 4.87 x 4.87 x 3.35 m

### HA100-1.25

- >100 Hz frequency of interest
- Medium to small-sized products
- Engineering Grade measurements
- Typical exterior size 6.01 x 6.01 x 3.63 m

### HA100-1.0

- >100 Hz frequency of interest
- Small-sized products
- Engineering Grade measurements
- Typical exterior size 5.49 x 5.49 x 3.63 m

### HA250-1.0

- >250 Hz frequency of interest
- Small-sized products
- Engineering Grade measurements
- Typical exterior size 3.96 x 3.96 x 2.83 m

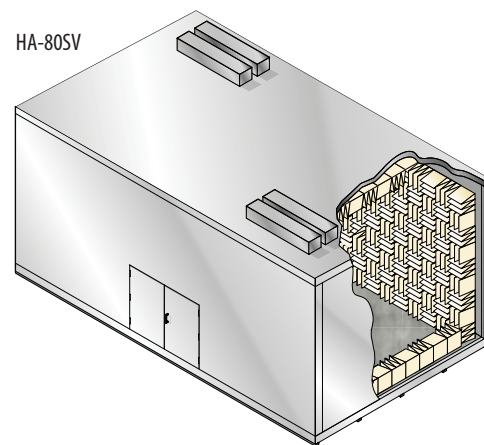



## P Series

P Series Predictable Field Enclosures are designed for making Engineering and Survey Grade measurements of products for quality control and sound power applications.

### P1-100

- >100 Hz frequency of interest
- Medium size products
- Engineering and Survey Grade
- Typical exterior size 5.18 x 5.18 x 3.43 m

### P2-100

- >100 Hz frequency of interest
- Medium size products
- Survey Grade
- Typical exterior size 3.35 x 3.35 x 2.96 m

### P3-250

- >250 Hz frequency of interest
- Small size products
- Survey Grade
- Typical exterior size 2.79 x 2.74 x 2.46 m

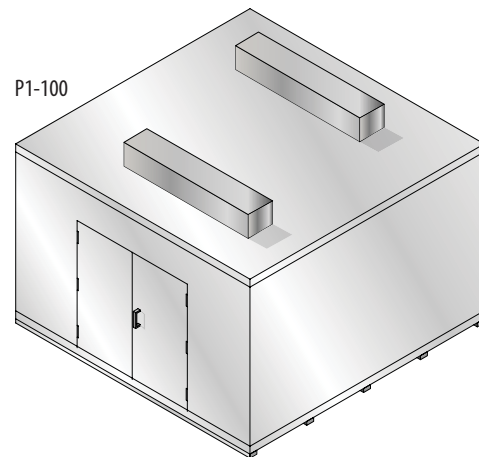

## RF and Microwave Test Cells

Test cells provide a free standing, moveable shielded environment for testing. They can be an economical solution for making bench top measurements in the laboratory on the shop floor when a test chamber is unavailable.

Applications include:

- Research and development
- Design qualification
- Pre-certification measurement
- In-line testing
- Product repair testing

### AMS-8050

The AMS-8050 is a compact, fully anechoic RF enclosure for making fast, over-the-air performance measurements of small wireless devices and mobile handsets. Measurements have shown good correlation with our full-sized certification chambers. The AMS-8050 includes a multi—axis positioner and EMQuest™ software for making 2-D and 3-D antenna pattern measurements. A SAM phantom is optional.

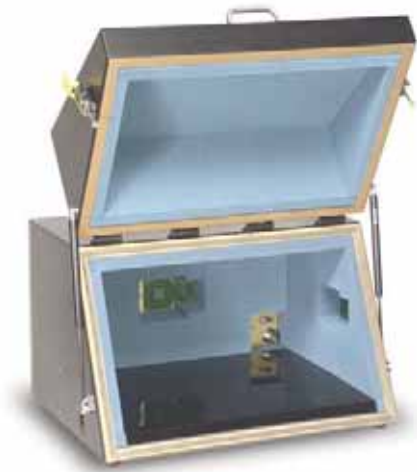





- 700 MHz – 6 GHz frequency range
- Measures active and passive antennas
- Makes 2-D and 3-D pattern measurements
- Integrated modular moveable system
- Typical exterior size 2.53 x 1.30 x 1.85 m

### **GTEM**

The GTEM is a tapered test cell that has the characteristics of a terminated transmission line with 50 ohm characteristic impedance. They are effective for rapid emission and immunity testing of electronic assemblies and equipment.

- 9 kHz – 5 GHz typical emissions frequency range
- DC – 20 GHz typical immunity frequency range
- Five Models:
  - 5402 - Typical exterior size 1.4 x 0.75 x 0.5 m
  - 5405 - Typical exterior size 3.0 x 1.6 x 1.7 m
  - 5407 - Typical exterior size 4.0 x 2.2 x 2.1 m
  - 5411 - Typical exterior size 5.4 x 2.8 x 2.3 m



### 5200 Series Test Cells

The 5200 Series are designed for bench top testing of small electronic assemblies and handheld devices. A number of options (depending on model) are available including RF couplers, filtered power and signal line feedthroughs, etc.

5211



### 5210, 5220 Series

- RF couplers: 700 MHz – 6 GHz typical frequency range
- Typical shield isolation >80 dB (frequency dependent)
- Typical exterior size 495 x 356 x 239 cm and larger

5225



### 5230 Series

- Typical shield isolation >120 dB (frequency dependent)
- Typical exterior size 600 x 500 x 500 cm and larger

5230



### 5240 Series

- Copper clad
- Typical shield isolation >120 dB (frequency dependent)
- Typical exterior size 300 x 300 x 300 cm and larger

5240



### SMART™ 1000

The SMART 1000 is a mini-sized reverberation chamber for bench top testing that retains the field isotropicity and homogeneity of our larger SMART chambers. Applications include measurement of total radiated power of wireless devices at specific frequencies.

- 1 – 40 GHz frequency range
- Makes both radiated immunity and emissions measurements
- Typical exterior size 1.1 x 0.7 x 0.6 m

SMART™ 1000





# Acoustic Small Device Enclosures

## SD Series

SD Series Small Device Test Enclosures are designed for making Engineering and Survey Grade measurements for product quality control.

### SD1

- >500 Hz cutoff frequency
- Small size products
- Production line screening
- Typical exterior size 111.8 x 111.8 x 111.8 cm

### SD2

- >250 Hz cutoff frequency
- Small size products
- Production line screening
- Typical exterior size 152.4 x 152.4 x 162.56 cm

### SD3

- Ideal for cell phone, audio services, and production line screening
- Typical exterior size 127 x 127 x 241.3 cm



# ETS–Lindgren Offers a Global



Minocqua, Wisconsin – USA

Glendale Heights, Illinois – USA

Durant, Oklahoma – USA

Cedar Park, Texas – USA

Stevenage – ENGLAND

Mesnil – FRANCE



# Presence with Local Support





# Company History

ETS-Lindgren is an innovator of systems and components for the detection, measurement and management of electromagnetic, magnetic, and acoustic energy. We adapt new technologies and apply proven engineering principles to create value-added solutions for our customers.

Our company began in 1995 when industry leaders EMCO, Rantec, and Ray Proof combined their resources to create EMC Test Systems. While our formation is recent, the roots of each company run deep. Ray Proof started as a supplier of medical X-ray shielding in 1932. Rantec led in the development of anechoic absorber and microwave chambers for the military during the early 1970s. EMCO (The Electro-Mechanics Company) formed as an outgrowth of magnetic field and radio frequency research in the 1960s.

In 1997, EMC Test Systems established a European presence with the purchase of Euroshield OY. The company is best known for developing pan-type RF shielding and a unique shielded door technology that remains the preferred choice today.

The acquisition of Lindgren RF Enclosures in 2000 doubled the size of our company and gave us immediate leadership in magnetic resonance imaging (MRI) shield rooms. It also provided an Asian presence through a Singapore office opened by Lindgren several years earlier. After the acquisition, our company name was changed to ETS-Lindgren.

Holiday Industries was also acquired in 2000. The company pioneered technology used in today's electromagnetic field sensing (EMF) systems for test and measurement, and health and safety applications. In 2002, ETS-Lindgren purchased Acoustic Systems, a leading supplier for acoustic test and measurement, audiology, and broadcast applications.

Japanese and Chinese RF shielding companies acquired during 2002 provided new manufacturing capacity in Asia. Since then, additional customer support has been added in Beijing, Shenzhen, and Shanghai. In 2006, ETS-Lindgren opened a new office in Taiwan to serve the growing customer base in that country. During the same year, the company announced a 4,180 square-meter (45,000 square-foot) expansion at its Cedar Park, Texas facility.

Headquartered in Cedar Park, Texas, ETS-Lindgren employs more than 750 professionals in offices and manufacturing facilities around the world. They are supported by a team of more than 60 local, independent representatives and distributors.

ETS-Lindgren is a subsidiary of ESCO Technologies, a leading supplier of engineered products for industrial and commercial markets. ESCO is headquartered in St. Louis, Missouri, and listed on the New York Stock Exchange with symbol ESE.

**ETS-Lindgren – Enabling Your Success™**



QUALITY MANAGEMENT SYSTEM  
CERTIFIED BY DNV  
**ISO 9001:2000**  
CEDAR PARK & EURA LOCATIONS

Accredited by  
  
**ACCREDITED**  
Lab Code: 115844/1702.01

  
Lab Code: 100286-0

**CTIA** Authorized Test Lab  
Lab Code: 20021212-00

**United States—Texas**

1301 Arrow Point Drive  
Cedar Park, TX 78613  
+1.512.531.6400 Phone  
+1.512.531.6500 Fax  
info@ets-lindgren.com

**Finland**

Mekaanikontie 1  
FI-27510, Eura, Finland  
+358.2.8383.300 Phone  
+358.2.8651.233 Fax  
info@ets-lindgren.eu.com

**France**

Centre D'Affaires Paris Nord  
Batiment Ampere  
93153 Le Blanc Mesnil France  
+33.1.48.65.34.03 Phone  
+33.1.48.65.43.69 Fax  
LRP.france@wanadoo.fr

**Japan**

4-2-6, Kohinata, Bunkyo-ku  
Tokyo, 112-0006 Japan  
+81.3.3813.7100 Phone  
+81.3.3813.8068 Fax  
info@ets-lindgren.co.jp

**Taiwan**

3F-2, No. 380, Sec 1  
Fu-Hsing South Road  
Virtuoso Enterprise Building  
Taipei, Taiwan 106  
+886.2.27023389 Phone  
+886-2-27023055 Fax  
info@ets-lindgren.com.tw

**United States—Illinois**

400 High Grove Blvd  
Glendale Heights, IL 60139  
+1.630.307.7200 Phone  
+1.630.307.7571 Fax  
info@ets-lindgren.com

**United Kingdom**

Boulton Road  
Pin Green Industrial Area  
Stevenage, Herts, SG1 4TH  
United Kingdom  
+44.1438.730.700 Phone  
+44.1438.730.751 Fax  
info@ets-lindgren.co.uk

**Singapore**

87 Beach Road  
# 06-02 Chye Sing Building  
Singapore 189695  
+65.65367078 Phone  
+65.65367093 Fax  
info@ets-lindgren.com.sg

**China**

B507A Technology  
Fortune Center  
No. 8 Xue Qing Road  
Haidian District  
Beijing P.R.C. 100083  
+86(10)8273.0877 Phone  
+86(10)8273.0880 Fax  
infochina@ets-lindgren.net

*Enabling Your Success*



WWW.ETS-LINDGREN.COM

1301 Arrow Point Drive • Cedar Park, Texas 78613 • e-mail: info@ets-lindgren.com

Dimensions provided in this brochure are nominal dimensions for standard doors and enclosures. Dimensions can vary based on your individual requirements. Information presented is subject to change as product enhancements are made. Actual product appearance may vary from representational photographs and illustrations shown. Contact the ETS-Lindgren Sales Department for current specifications.

6/07 5k W/JMG © 2007 ETS-Lindgren